

Christmas Churn Dash - 12.5 Finished

Presented Nov. 2, 2024 – Return Nov. 16, 2023

This block uses 3 different fabrics. Please use light, medium and dark fabrics with high contrast and small prints in red, white and green for a Christmas block.

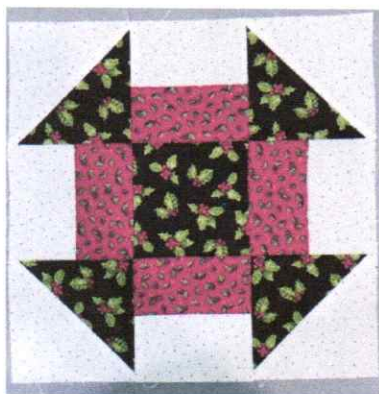

In this block the white with red polka dots is the light fabric

The red bkgnd with green holly is medium fabric

The black bkgnd with green holly and berries is the dark fabric

From light fabric cut: 2 – 6” squares and 4 rectangles – 2.5” x 4.5”

From medium fabric cut: 4 rectangles – 2.5” x 4.5”

From dark fabric cut: 2- 6” squares and 1 – 4.5” square

All seams are $\frac{1}{4}$ ”

1. Make 4 HST from the light and dark 6” squares. Press seams to the light. Trim these 4 HST to 4.5”
2. Make 4 units using the light and medium 2.5 x 4.5 rectangles. Press seams toward the medium.
3. Stitch pieces together to create rows. When making your rows be sure to orient your light fabric to the outer edge of the block.
4. Stitch rows together to complete the block. Press seams toward the outer edges (up and down) of the block.
5. Trim to 12.5.

Thank you for participating!!

November Lottery Block – Christmas Mosaic – Advanced

12 inch finished block

Due at the first meeting in November (Nov. 2, 2023)

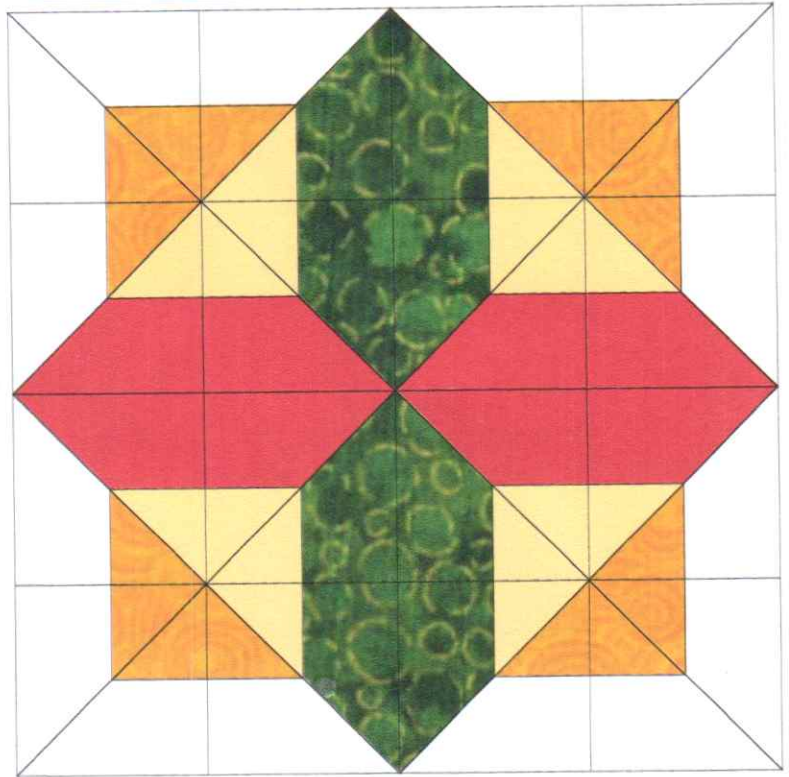
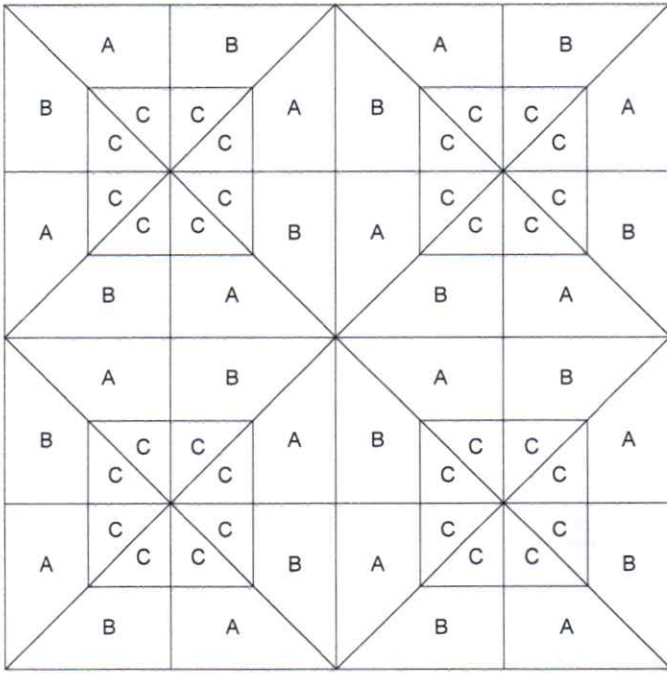

Method 1 Templates

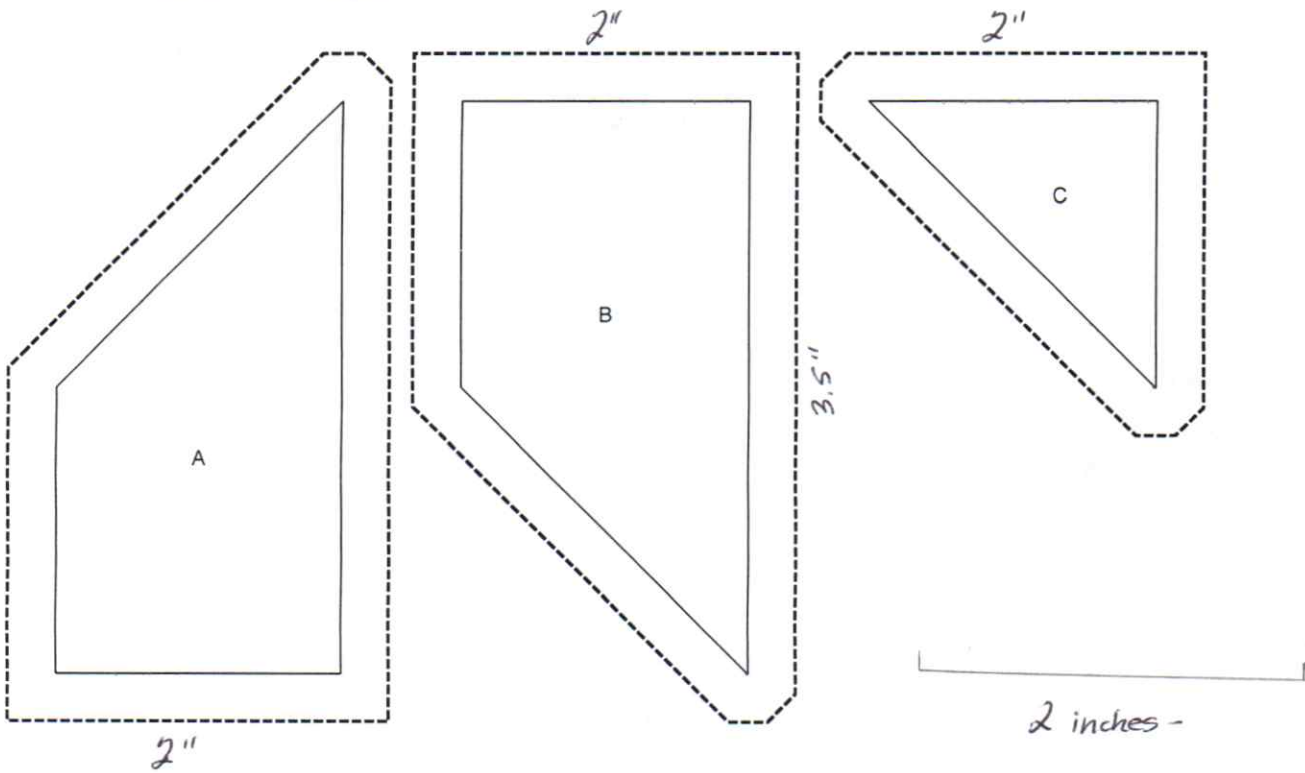

-

Method 2 Templates

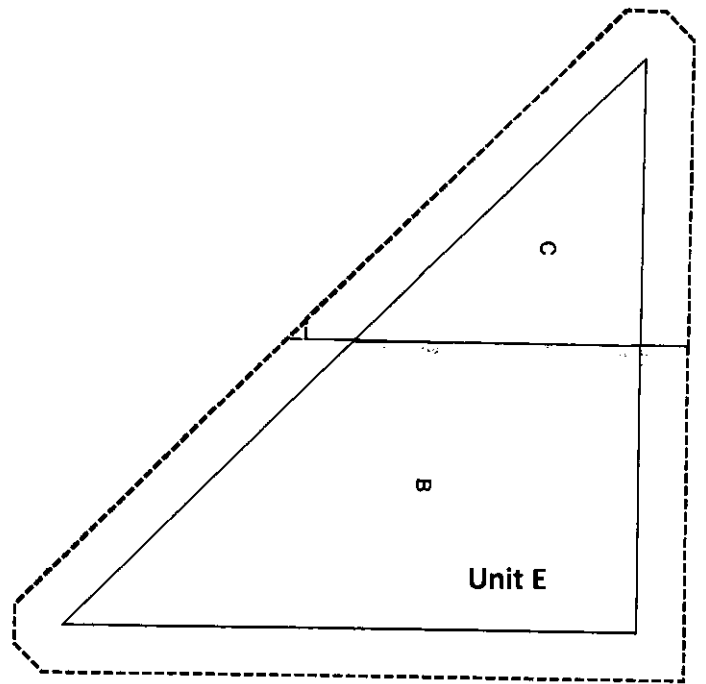
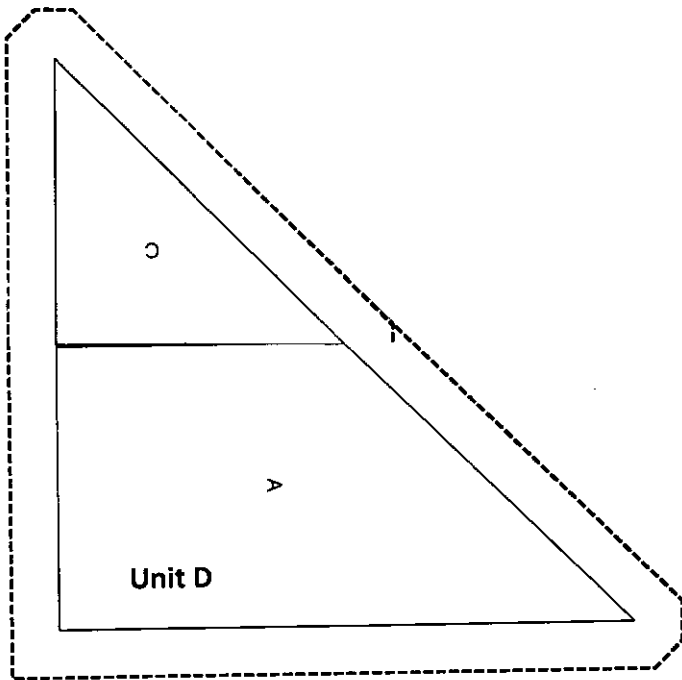

Fabric Requirements:

Dark green- .10 metres

Christmas red - .10 metres

Dark Gold print - .10 metres

Light Gold print - .10 metres (may need .20 metres if fabric has been cut off grain)

Cream tone on tone or print - .10 metres (may need .20 metres if fabric has been cut off grain)

INSTRUCTIONS – Method 1

1. Cut the fabric into 2" x WOF strips (as indicated in Cutting Chart at end of instructions)
2. Using the chart as a guide, cut the required number of pieces of each template A, B and C from each strip.
3. Assemble the A and B pieces and add the C piece to each to create the triangle units. Be sure to check the diagram often to be sure you are aligning them in the right direction.
4. After you've completed the first AC or BC piece, check the measurements carefully to ensure that the measurements are accurate before moving on to finish the rest.
5. When all the AC and BC pieces are completed, lay out the units in the correct orientation before sewing them into larger units. Lay the completed units back on the work board to ensure that they are correctly oriented.
6. When all pieces have been assembled, press carefully and measure the whole block. It should measure 12.5 x 12.5 inches.
7. Note: This method takes a bit longer, but is the most economical use of the fabric.

INSTRUCTIONS- Method 2

1. After cutting the strips as indicated in the chart, sew one dark green and one light gold strip together lengthwise. Do the same with the red and light gold strip. For the cream /dark gold strips, you will sew two of those as above. Press carefully. Check the measurements before proceeding to cutting the templates.
2. Using the templates provided, or a Fons & Porter Triangle Trimmer template (the pink one - it's exactly the right size), cut 4 Unit D from the green/gold strip and 4 Unit D from the red/gold strip. You will cut 8 Unit Ds from the cream/dk gold strip.
3. Using Unit E template (or flip the Fons & Porter triangle trimmer) and cut 4 green/gold, 4 red/gold and 8 cream/dark gold units from the strips.
4. I assembled the units into 4 quadrants, then sewed the quadrants together. Be sure the pieces are oriented in the right direction before sewing the seams.
5. When you have finished sewing the units together, press carefully. Measure again. Block should measure 12.5 x 12.5 inches.

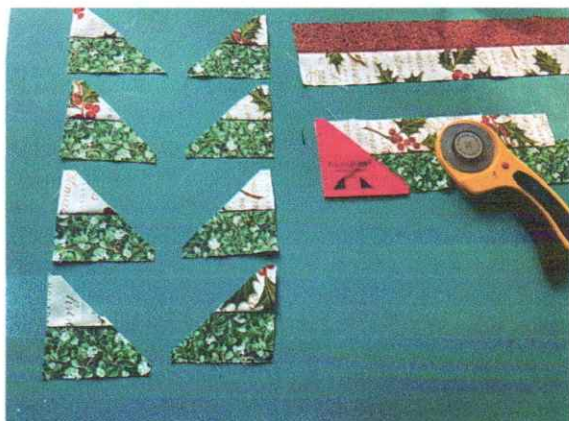

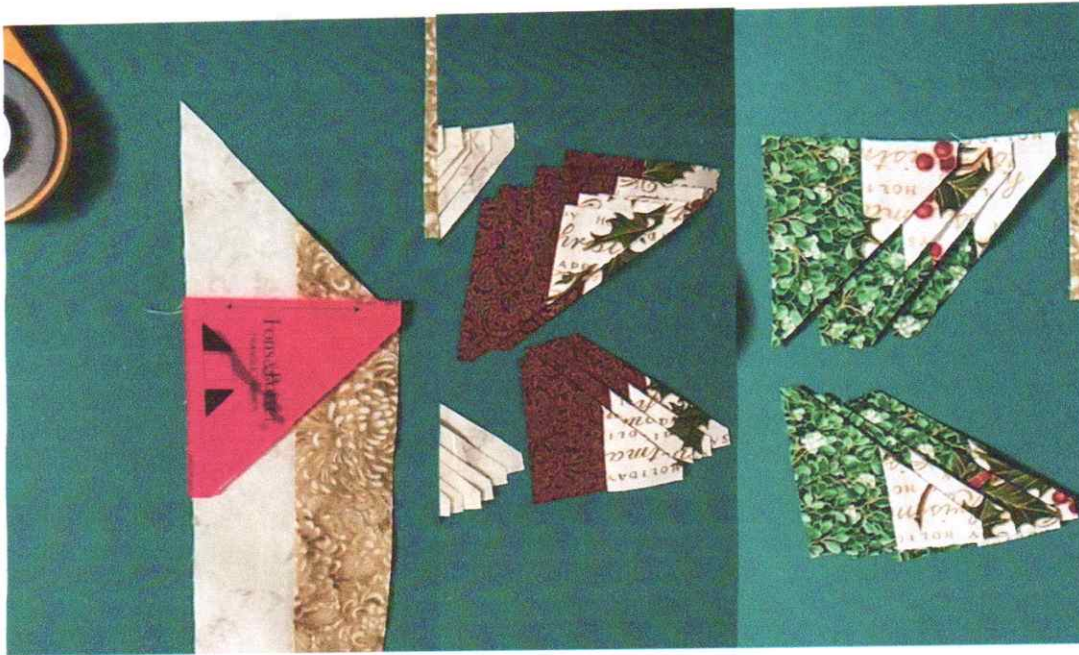

Note: Experienced quilters will have other favourite methods for assembling this block. Use whatever has worked well for you in the past. The challenge here is accurate seams and making certain the pieces are oriented in the right direction. Even small discrepancies in piecing can result in blocks that aren't the right size. Ask me why I know this!!

Note 2: Method 2 will produce a lot of leftover units. You can use these to make other blocks for projects such as placemats, etc. They will be smaller, but can be very attractive too.

If you have any questions, please contact me for clarification, extra tips, etc.
Hélène Chenard

Cutting Chart – for Christmas Mosaic Lottery Block

Template piece	Colour	Number to Cut	Fabric Requirements
A	Dark Green	4	2" strip x WOF
	Red	4	2" strip x WOF
	Cream	8	2" strip x WOF x 2
B	Dark Green	4	You should have enough fabric from the 2" strips cut for piece A
	Red	4	
	Cream	8	
C	Lt. Gold	16	2" strip x WOF x 2
	Dark gold	16	2" strip x WOF x 2
Alternate – D(unit)	Dark green/ Lt. gold	4	2" strip of green sewed lengthwise to 2 " strip of lt gold
	Red/ Lt. gold	4	2" strip of red sewed lengthwise to 2 " strip of lt gold
	Cream / dk gold	8	2" strip cream sewed lengthwise to 2" strip dk gold (You will need two of these)
Alternate – E(unit)	Dark green/ Lt. gold	4	2" strip of green sewed lengthwise to 2 " strip of lt gold
	Red/ Lt. gold	4	2" strip of red sewed lengthwise to 2 " strip of lt gold
	Cream / dk gold	8	2" strip cream sewed lengthwise to 2" strip dk gold (you will need 2 or these)